

AREA DIESEL SERVICE, INC.



CATERPILLAR REPLACEMENT TURBOS & INJECTORS



CAT POWER - This brochure contains a comprehensive lineup of stock, upgrade, and performance replacement turbochargers for Caterpillar applications.

These turbochargers are designed and engineered using the latest findings in aerodynamic technology, mechanics, and materials technology. They are adapted to optimally meet specific O.E. Engine requirements.

KITS AND CONVERSIONS - Twin to Single Turbocharger Conversion Kits are available for 2008 through 2010 C15 ACERT (WITH DPF) for Peterbilt and Kenworth applications with SDP code. Twin to Single conversion kits for 2004 through 2007 C13 ACERT Peterbilt and Kenworth, as well as 2004 through 2007 C15 ACERT Peterbilt, Kenworth, Freightliner, and International applications.

CROSS REFERENCE - Use the following pages to find the perfect fit. Don't see your specific reference number? Contact a representative for assistance. With the largest inventory of turbochargers in the Midwest, we'll find the part you need!

INJECTORS - Replacement C10, C12, C13, C15, & 3406E injectors that partner-up with the replacement turbocharger applications in this booklet.



BorgWarner

Not Just Quality. Delphi Quality.

ANY AND ALL MANUFACTURER NAMES, MODELS, PART NUMBERS, AND PRODUCT IMAGES HEREIN ARE PROPERTY OF THEIR RESPECTIVE OWNERS AND ARE BEING USED FOR REFERENCE PURPOSES ONLY. PRICING AND AVAILABILITY ARE SUBJECT TO CHANGE.



WWW.AREADIESEL.COM

AREA DIESEL SERVICE, INC.



(800) 637-2658 - 1300 N UNIVERSITY ST. CARLINVILLE, ILLINOIS 62626

(800) 237-4692 - 1440 NE 56TH ST. PLEASANT HILL, IOWA 50327

(317) 203-3331 - 5732 W 71ST ST. INDIANAPOLIS, INDIANA 46278

NOW AVAILABLE!

CATERPILLAR C13 TRUCK ENGINE GT4088BS TURBOCHARGER



P/N:
752538-9013

APPLICATION:

- Caterpillar C13 Truck Engine
- High Pressure
- Additional Part Numbers: 10R8733, 284-7707, 259-2400, 252-4590

CATERPILLAR C13 TRUCK ENGINE GTA4702B TURBOCHARGER



P/N:
743279-9001

APPLICATION:

- Caterpillar C13 Truck Engine
- High Mount, Low Pressure
- Additional Part Numbers: 10R2027, 239-5581, 231-4140

CATERPILLAR C15 TRUCK ENGINE GT4294BS TURBOCHARGER



P/N:
741154-9011

APPLICATION:

- Caterpillar C15 Truck Engine
- High Mount, High Pressure
- Additional Part Numbers: 10R2407, 251-4820, 233-1596, 233-1592, 233-1589, 269-4176, 251-4819, 269-4177

CATERPILLAR C15 TRUCK ENGINE GTA5518B TURBOCHARGER



P/N:
741155-9003

APPLICATION:

- Caterpillar C15 Truck Engine
- High Mount, Low Pressure
- Additional Part Numbers: 10R1888, 232-1811, 232-1805, 231-6616

ANY AND ALL MANUFACTURER NAMES, MODELS, PART NUMBERS, AND PRODUCT IMAGES HEREIN ARE PROPERTY OF THEIR RESPECTIVE OWNERS AND ARE BEING USED FOR REFERENCE PURPOSES ONLY. PRICING AND AVAILABILITY ARE SUBJECT TO CHANGE.



WWW.AREADIESEL.COM



(800) 637-2658 - 1300 N UNIVERSITY ST. CARLINVILLE, ILLINOIS 62626
(800) 237-4692 - 1440 NE 56TH ST. PLEASANT HILL, IOWA 50327
(317) 203-3331 - 5732 W 71ST ST. INDIANAPOLIS, INDIANA 46278

REPLACEMENT TURBOS FOR CAT 3406 & C15

BorgWarner SX Series Turbochargers

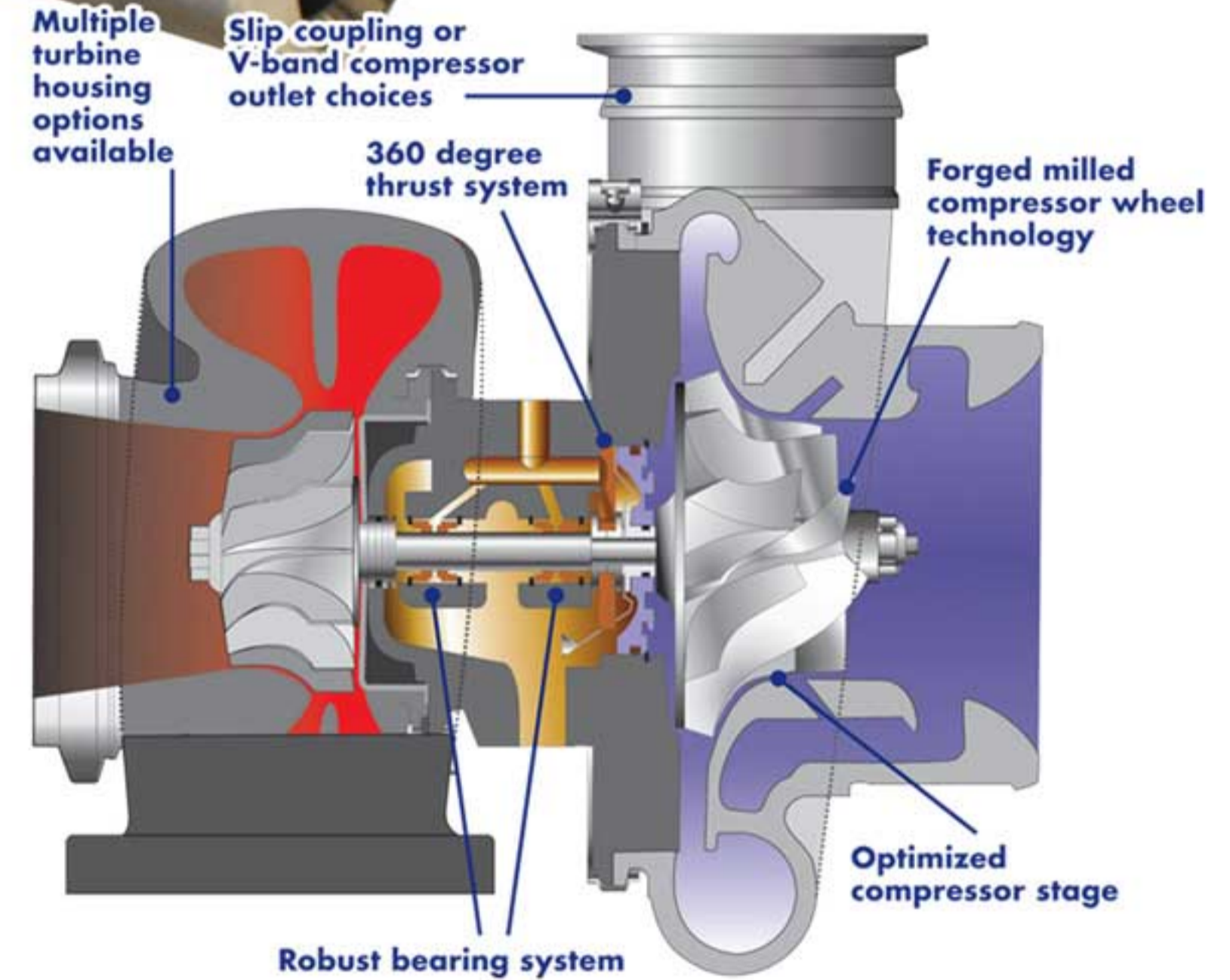

Features & Benefits

- 360 degree thrust system enhances turbochargers durability to help get the most out of your investment
- Forged milled compressor wheel technology (FMW) for increased component strength and life cycle
- Optimized compressor stage and extended tip compressor wheel technology for efficient airflow and improved throttle response
- One year, 100,000 mile warranty

ANY AND ALL MANUFACTURER NAMES, MODELS, PART NUMBERS, AND PRODUCT IMAGES HEREIN ARE PROPERTY OF THEIR RESPECTIVE OWNERS AND ARE BEING USED FOR REFERENCE PURPOSES ONLY.



WWW.AREADIESEL.COM

Original Turbochargers
177148 & 175963
can be replaced by
14969880000 - 0003

FRANCHISE



DISTRIBUTOR

Area Diesel Service, Inc.



BorgWarner

BorgWarner SX Series Turbochargers

Reference no.	Engine	Litres	Original turbo no.	Turbo part no.	Model spec.
0R6986	3406E 475 HP	14.64	177148	466445-0015	S410G
0R6989	3406E 425 HP	14.64	177148	466445-0018	S410G
0R7201	3406E 475 HP	14.64	177148	466445-9021	S410G
0R7201	3406E 475 HP	14.64	177148	466445-0021	S410G
0R7203	3406E 425 HP	14.64	177148	466445-9023	S410G
0R7203	3406E 425 HP	14.64	177148	466445-0023	S410G
0R7223	3406E 435 - 550 HP	14.64	177148	471142-9005	S410G
0R7275	3406E/3456/C16	15.8	175963	471147-9007	S410G-105H55SAWM/1.65TM1
0R7285	3406E/3456/C16	15.8	175963	705152-0003	S410G-105H55SAWM/1.65TM1
0R7299	3406E Low HP	14.64	177148	170354	S410G
0R7310	3406E	14.64	177148	704604-0007	S410G
0R7923	3406E	14.64	177148	704604-0007	S410G
0R7924	3406E/3456/C16	15.8	175963	705152-0007	S410G-105H55SAWM/1.65TM1
10R1065	3406E/C15	14.64	177148	732915-0001	S410G
124-3032	3406E 475 HP	14.64	177148	466445-0015	S410G
124-3035	3406E 425 HP	14.64	177148	466445-0018	S410G
136-6390	3406E 455 - 550 HP	14.64	177148	471142-0003	S410G
141-8937	3406E 475 HP	14.64	177148	466445-0021	S410G
141-8939	3406E 425 HP	14.64	177148	466445-0023	S410G
146-4328	3406E 435 - 550 HP	14.64	177148	471142-0005	S410G
159-8542	3406E/3456/C16	15.8	175963	471147-9007	S410G-105H55SAWM/1.65TM1
161-6352	3406E/3456/C16	15.8	175963	705152-0003	S410G-105H55SAWM/1.65TM1
166-6752	3406E Low HP	14.64	177148	170354	S410G
167-9271	3406E	14.64	177148	704604-0007	S410G
196-5951	3406E	14.64	177148	704604-0007	S410G
196-5952	3406E/3456/C16	15.8	175963	705152-0007	S410G-105H55SAWM/1.65TM1
222-1133	3406E/C15	14.64	177148	732915-0001	S410G

S410SX PART NUMBER DEPLOYMENT MATRIX

Part #	Model	Compressor Cover Configuration	Compressor Wheel Technology	Compressor Wheel Outside Diameter	Compressor Wheel Inducer	Turbine Wheel O.D. (Inducer)	Turbine Housing A/R	Turbine Housing Configuration	Estimated HP*
14969880000	S410SX	Cat Style Slip Coupling	Forged Milled	105 mm	78 mm	96 mm	1.32	Non-Wastegated	600
14969880001	S410SX	Cat Style Slip Coupling	Forged Milled	110 mm	80 mm	96 mm	1.58	Non-Wastegated	750
14969880002	S410GX	Cat Style Slip Coupling	Forged Milled	110 mm	80 mm	96 mm	1.65	Wastegated	800
14969880003	S410GX	Cat Style Slip Coupling	Forged Milled	110 mm	82 mm	96 mm	1.65	Wastegated	900

*** RESULTS MAY VARY BY ENGINE. PLEASE MATCH ESTIMATED HP TO APPLICATION HP CAPABILITIES. ADDITIONAL MODIFICATIONS ARE REQUIRED TO ACHIEVE INCREASED HP LEVELS.**

ANY AND ALL MANUFACTURER NAMES, MODELS, PART NUMBERS, AND PRODUCT IMAGES HEREIN ARE PROPERTY OF THEIR RESPECTIVE OWNERS AND ARE BEING USED FOR REFERENCE PURPOSES ONLY.



WWW.AREADIESEL.COM

AREA DIESEL SERVICE, INC.



(800) 637-2658 - 1300 N UNIVERSITY ST. CARLINVILLE, ILLINOIS 62626

(800) 237-4692 - 1440 NE 56TH ST. PLEASANT HILL, IOWA 50327

(317) 203-3331 - 5732 W 71ST ST. INDIANAPOLIS, INDIANA 46278

C13 ACERT TWIN TO SINGLE TURBO CONVERSION KIT

BIG CAT PERFORMANCE - Twin to Single Turbocharger Conversion Kits for 2004 through 2007 C13 ACERT applications.

- + Improved Fuel Economy
- + Increased Reliability
- + Reduced Maintenance
- + Longer Engine Life
- + Faster Spool-Up
- + Cooler Operation
- + Lower Repair Costs
- + Sharper Throttle Response
- + Simplify your Acert & your life!

BIG CAT

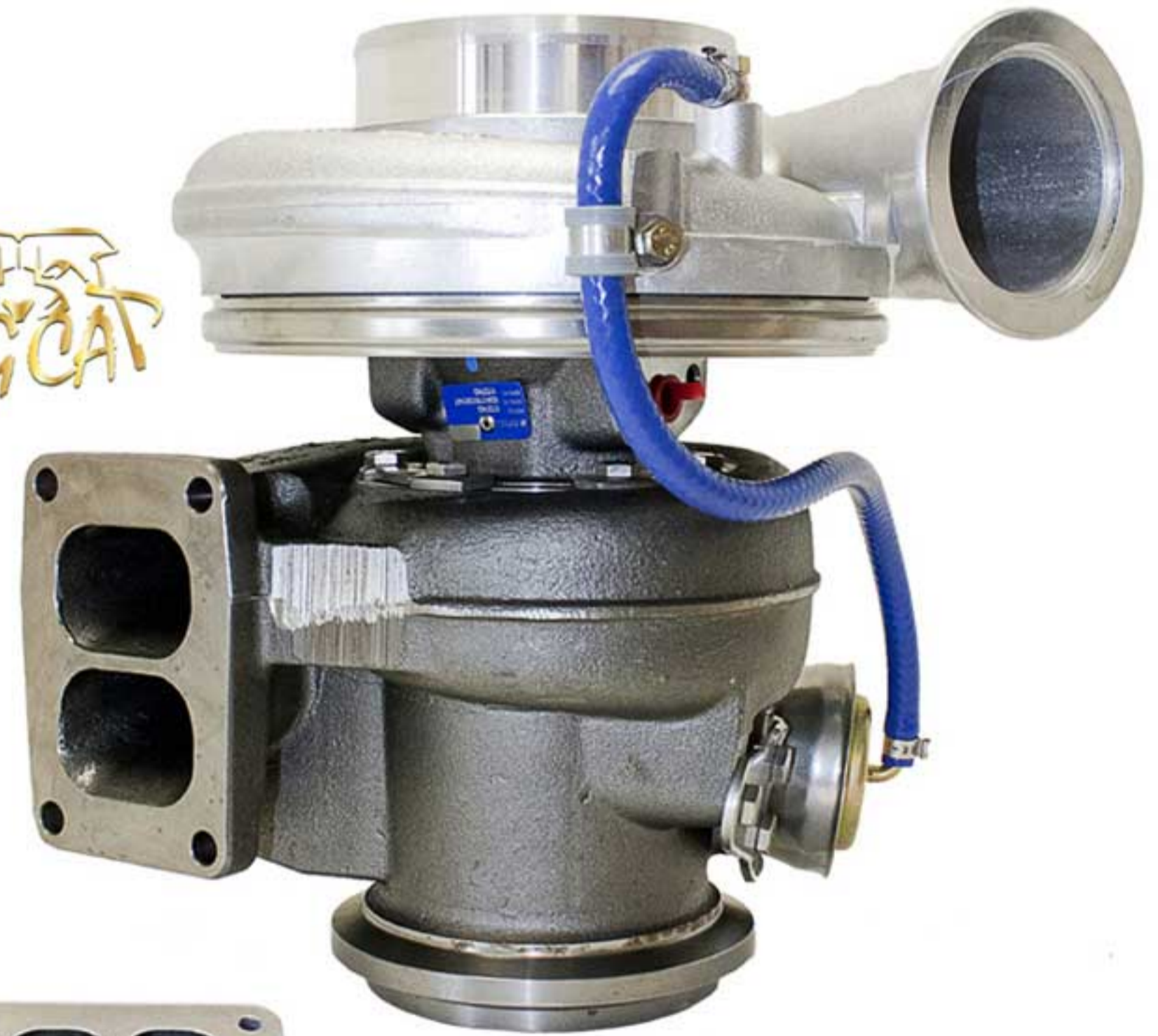

Complex Mess to
Simple High Performance!



Before



After



P/N REFERENCE: - TEHDC13A



TWIN TO SINGLE TURBO CONVERSION KITS INCLUDE:

- TRUCK EDITION PERFORMANCE MODULE - MANIFOLD
- BIG CAT PERFORMANCE TURBO - ADDITIONAL KIT COMPONENTS

(KIT COMPONENTS MAY VARY - DEPENDING ON TRUCK MODEL BEING CONVERTED.)

ANY AND ALL MANUFACTURER NAMES, MODELS, PART NUMBERS, AND PRODUCT IMAGES HEREIN ARE PROPERTY OF THEIR RESPECTIVE OWNERS AND ARE BEING USED FOR REFERENCE PURPOSES ONLY. PRICING AND AVAILABILITY ARE SUBJECT TO CHANGE.



WWW.AREADIESEL.COM



C15 ACERT WITH & WITHOUT DPF TWIN TO SINGLE TURBO CONVERSION

BIG CAT PERFORMANCE - Twin to Single Turbocharger Conversion Kits for 2008 through 2010 C15 ACERT Peterbilt and Kenworth applications with SDP code.

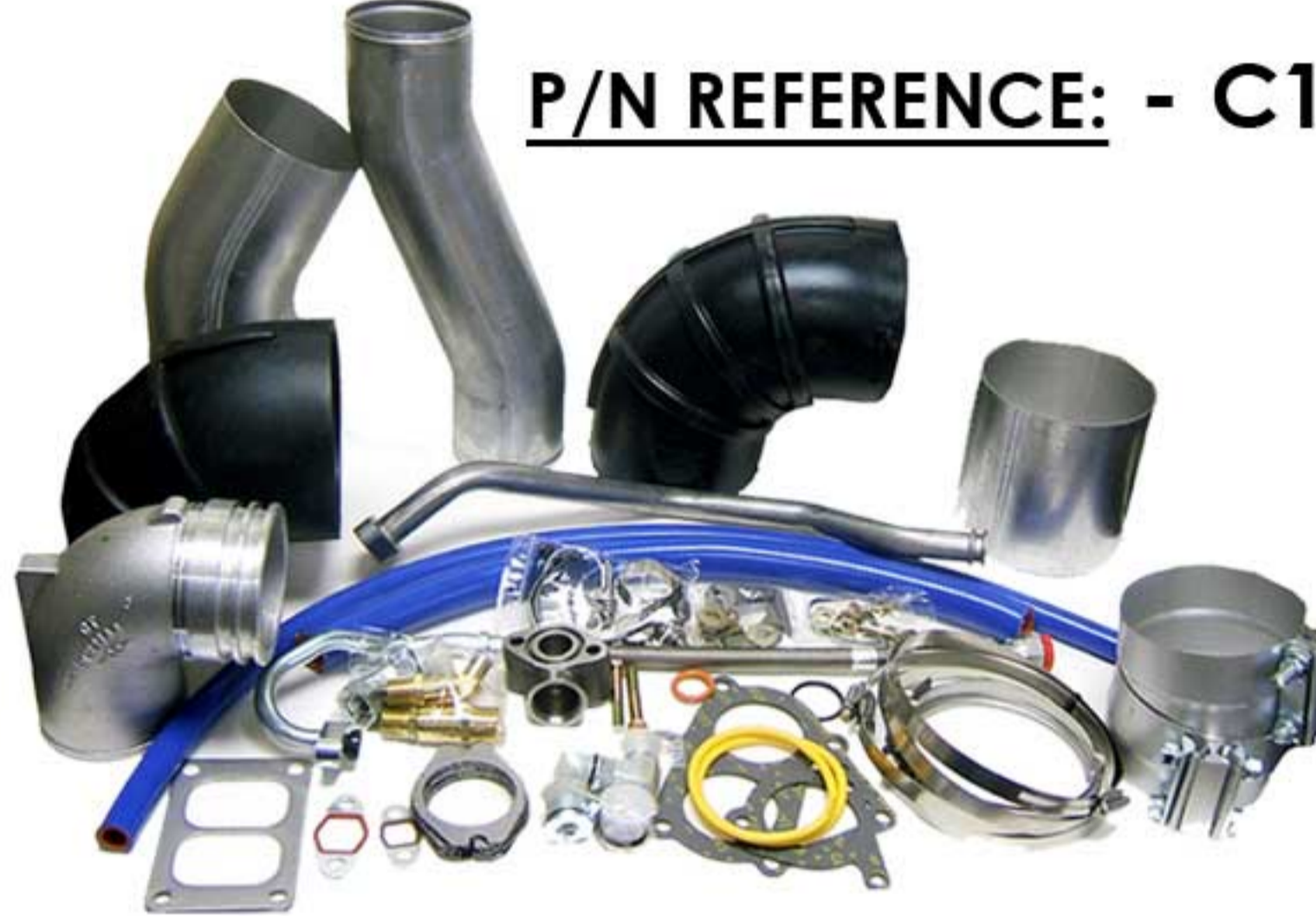

P/N REFERENCE: - C15AWDPF

**TWIN TO SINGLE TURBO
CONVERSION KITS INCLUDE:**

- MANIFOLD
- BIG CAT PERFORMANCE TURBO
- ADDITIONAL KIT COMPONENTS

(KIT COMPONENTS MAY VARY -
DEPENDING ON TRUCK MODEL
BEING CONVERTED.)

Complex Mess to Simple High Performance!

- + Improved Fuel Economy
- + Increased Reliability
- + Reduced Maintenance
- + Sharper Throttle Response
- + Longer Engine Life
- + Faster Spool-Up
- + Cooler Operation
- + Lower Repair Costs



BIG CAT PERFORMANCE - Twin to Single Turbocharger Conversion Kits for 2004 through 2007 C15 ACERT Peterbilt, Kenworth, Freightliner, and International applications.



**P/N REFERENCE: - TEHDC15AF - TEHDC15AK
- TEHDC15AP - TEHDC15AIN**

**TWIN TO SINGLE TURBO
CONVERSION KITS INCLUDE:**

- TRUCK EDITION PERFORMANCE
MODULE
- MANIFOLD
- BIG CAT PERFORMANCE TURBO
- ADDITIONAL KIT COMPONENTS

(KIT COMPONENTS MAY VARY -
DEPENDING ON TRUCK MODEL
BEING CONVERTED.)

ANY AND ALL MANUFACTURER NAMES, MODELS, PART NUMBERS, AND PRODUCT IMAGES HEREIN ARE PROPERTY OF THEIR RESPECTIVE OWNERS AND ARE BEING USED FOR REFERENCE PURPOSES ONLY. PRICING AND AVAILABILITY ARE SUBJECT TO CHANGE.



AREA DIESEL SERVICE, INC.



CROSS REFERENCE

CAT REF. #	TYPE	MODEL YRS.	ENGINE	LITERS	MODEL SPECS.	KW	RPM	TURBO SVC #	REPLACED BY	TURBO P/N
OR5384		1974-05	3408	18	4MF-731			178093		180218
OR5721		1986-12	3306B	10.3	S4DS			178107		196557
OR5725		1987-01	3406B	14.6	S4DS006			178103		196544
OR5726		1987-01	3406B	14.6	S4DS010			178104		196548
OR5728			3406	14.6	S4DS010			178105		312006
OR5728		1987-01	3406	14.6	S4DS010			178105		196549
OR5733	Truck	1990-02	3406B	14.6	S4DS025	343	1800	178063		466372-X002
OR5757		1982-02	3408	18	4MF-731			178097		186553
OR5759			3306		4MF-721			179601		187166
OR5760			3408		4MF-731			179602		187178
OR5805			3306		FC-302			172497		185638
OR5806		1981-09	3306	10.3	4LF-302			173721		182453
OR5807			3306		3LM-373			172495		184119
OR5808					3LM-289			172494		182248
OR5810					E-304			149170		149170
OR5811			3306		3LM-373			172496		185841
OR5812		1981-06	3306		E-504			178048		180287
OR5813			3306		EC-283			179603		188149
OR5826			D379B		F-302			172488		182765
OR5827			D399		4HD-857			178051		316213
OR5827		1976-06	D399		4HD-857			178051		182781
OR5830		1976-06	D399		4MD-755			178095		182831
OR5831	Industrial	1979-03			4HF-857			178052		184980
OR5832			G633C		4MD-455			178001		151905
OR5842			D353D		4HD-755			178050		182779
OR5845		1979-08			V4HD-855			178096		185490
OR5852		1974-12	3306		4MD-354			177998		143145
OR5854			D330		4MD-354			144499	144199	144499
OR5855			D379B		4ME-455			147738		147738
OR5948		1987-02	3306	10.3	S4DS001			178101		196542
OR5949		1987-02	3306	10.3	S4DS011			178106		196554
OR5977	Gen Set		3114T & TA		S2AS013			197240R		197240R
OR6051		1989-07	3406 @ 460		S4TS508	343		178120		198123
OR6165		1990-09	3406	14.6	S3BSL059			178130		199079
OR6166	Truck	1990-09	3406B	14.6	S3BSL058	261	1900	178062		199086
OR6167		1990-02	3406	14.6	S4DS025	261	2100	178131		199114
OR6167	Truck	1990-02	3406B	14.6	S4DS025	261	2100	178131		199114
OR6170	Truck	1990-02	3406B	14.6	S4DS025	343	1800	178063		199119
OR6229					S2AS015			199106		199106
OR6235		1990-09	3406B		S4DS027	257	2200	178065		199351
OR6299		1992-07	3408	18	S4TS522	338		178132		199502
OR6333		1987-02	3406 D8N		S4DS006			178059		196547
OR6334		1987-05	3406	14.6	S4DC006			178108		196564
OR6340		1987-02			S4DS			178102		196543
OR6376	Truck/Bus	1991-04	3306	10.3	S3BGL082	224	2000	178066		199661
OR6377		1991-04	3306	10.3	S3BGL114	224	2000	178013	167867	199662
OR6478			3126 @190 HP		S200S001			179580		167433
OR6618		1992-07	3408	18	S4TS522	338		178132		199502
OR6686			3176,3176B		S3BSL102			179571		166490
OR6692	Quarry truck		3412 775		S4DSL029			179572		166669
OR6694			3406E	14.64	S410			174269		466423-9001
OR6724		1993-03	3116 @215 HP	6.6	S2EGL099	160	2200	178070		166810
OR6726			3116 @185,200 HP		S2EG099			178006		166802
OR6729		1993-02	3116 @250 HP	6.6	S2EG070	187	2200	178071		166812
OR6730			3116 @170,185 HP		S2EGL069			178005		166799
OR6743			3116	3.6	S2EGL094	157	2300	179573		166773
OR6804		2009-01	3406	14.6	S4DSL031			179596		167053
OR6817	Truck	1993-08	3176	10.3	S3AS019			178073		167181
OR6818	Truck	1993-08	3176	10.3	S3AS017			178074		167182
OR6819	Truck	1993-08	3176	10.3	S3AS017			178075		167183
OR6820	Truck	1993-08	3176	10.3	S2ESL051	261	1800	178010		167186
OR6821	Truck	1993-08	3176	10.3	S2ESL079	261		178076		167187



WWW.AREADIESEL.COM

AREA DIESEL SERVICE, INC.



CROSS REFERENCE

CAT REF. #	TYPE	MODEL YRS.	ENGINE	LITERS	MODEL SPECS.	KW	RPM	TURBO SVC #	REPLACED BY	TURBO P/N
OR6829	Truck	1997-01	3306	10.3	S3BGL114	224	2000	178009		167168
OR6830	Truck	1993-07	3306	10.3	S3BGL114	224	2000	178008		167166
OR6837			3306B		S3BSL115			179577		167185
OR6875					S3BSL102			179571		167366
OR6881			3306		S3BSL119			179578		167384
OR6882					S3BSL120			179579		167386
OR6889					S3BSL119			179578		167384
OR6890		1994-01	3116 @250 HP	7	S2EGL100	187		178011		167197
OR6935			3406E	14.64	S410			174269		466423-9003
OR6942		1994-06	3126 @250 HP	7	S200G001	187		178077		167434
OR6943	Truck	1994-06	3126 @275 HP	7	S200G001	205	2200	178078		167435
OR6957	Truck	1990-02	3406B	14.6	S4DS025	343	1800	178063		466903-X001
OR6981			3306 350H, C65D, 615		S3BSL128			179581		167972
OR6984			3406E	14.64	S410			174269		466423-9004
OR6986			3406E @475 HP	14.64	S410G	355		177148		466445-0015
OR6988	Truck	1994-01	3406E	14.64	S410G	325	1800	174259		466445-0017
OR6989			3406E @425 HP	14.64	S410G	317		177148		466445-0018
OR6990	Truck	1994-01	3406E	14.64	S410G	372	1800	174260		471036-0001
OR7000		1995-11	3116	6.6	S2ESL094	130		178080		168190
OR7009	938F Loader	1995-11	3116T @110 HP	6.6	S2ESL105	82		178016		168360
OR7010	938F Loader	1995-10	3116T @180 HP	6.6	S2ESL105	134		179583		168362
OR7014	Excavator		3116T M318		S2ESL105			179584		168369
OR7052		1995-06			S3BSL128			179585		168443
OR7075	Truck Off-Highway	1995-10	3406C 773&775	14.6	S4DS-114H55DAXM/1.58VTF97H1	313	1900	178465		168665
OR7087	Truck	1999-01	3406C	14.59	S410G	315	1800	174259		471066-0001
OR7107		1996-03	3116	6.6	S2EGL094	130		178018		168936
OR7139		1996-05	3176C	10.3	S3BSL060	250	2000	178020		169049
OR7142	Truck	1996-07	3406E @355-410 HP	14.64	S410	305		174269		169060
OR7152		1996-07	3406C @425 HP	14.64	S410G	317		177148		169227
OR7194	Loader 998	1995-01	3408	18	S4DS034	326	2000	178079		167690
OR7194	Truck 769	1995-01	3408	18	S4DS034	326	2000	178079		167690
OR7197			3116 @125/140 HP		S200S017			179586		169439
OR7199	Truck	1994-01	3406E	14.64	S410G			174259		471119-9001
OR7200			3406E	14.64	S410			174269		466423-9005
OR7200	Truck	1994-06	3406E	14.64	S410	280	1800	174269		466423
OR7201			3406E @475 HP	14.64	S410G	355		177148		466445-0021
OR7201	Truck		3406E @475 HP	14.64	S410G	355		177148		466445-9021
OR7202	Truck	1994-01	3406E	14.64	S410G	325	1800	174259		466445-0022
OR7203			3406E @425 HP	14.64	S410G	317		177148		466445-0023
OR7203	Truck		3406E @425 HP	14.64	S410G	317		177148		466445-9023
OR7205	Truck	1994-01	3406E	14.64	S410G	372	1800	174260		471120-0001
OR7213	Truck	1996-11	3306C	10.3	S3BGL114	224	1800	178023		169490
OR7214	Truck	1996-11	3306C	10.3	S3BGL114	224	1800	178024		169491
OR7215		1994-09	3306 @300 HP	10.3	S3BGL114	234	2000	178013		167867
OR7223	Truck	1998-01	3406E @435 - 550 HP	14.64	S410G	404	1800	177148		471142-9005
OR7251	Euro Truck	1997-07	C10	10.3	S3BSL157			178026		169817
OR7255	Marine		3126E		S330W057			179609	171475 for OE	170245
OR7259	Mining	1997-10	3306B	10.3	S3BSL159	123	2200	178025		169902
OR-7275	Truck	1998-01	3406E, 3456, C16	15.8	S410G-105H55SAWM/1.65TM1	441	2100	175963		471147-9007
OR7284		1998-04	3406E	14.64	S410	325		174269		170083
OR-7285	Truck	1998-01	3406E, 3456, C16	15.8	S410G-105H55SAWM/1.65TM1	441	2100	175963		705152-0003
OR7299		1998-08	3406E Low HP	14.64	S410G			177148		170354
OR7310	Truck	1994-01	3406E	14.64	S410G	404	1800	177148		704604-0007
OR7443	793 HD Truck	2000-08	3516B HD	70	S510C004	1715	1750	178469	176864	171654
OR7569	Truck	2000-04	3126B	7	S300G-83H36DSPM/0.80VTF74DA1	224	2400	178468		171574
OR7573	Truck	2000-04	3126B	7	S300G-83H36DS-PM/0.80VTF74DA1	246	2400	178029		171566
OR7584	Truck	2000-09	3126B	7	S200A045	140	2200	178031		171730
OR7586	Truck	2000-09	3126B	7	S200S044	140	2200	178470		171717
OR7588	Truck	2000-10	3126B	7	S200G-80H/33DM-TM/0.80VTF70UU9	172	2200	179590		171753
OR7922	Truck	1999-01	3406E	14.59	S410G	320	1800	174259		704604-0006



WWW.AREADIESEL.COM

AREA DIESEL SERVICE, INC.



CROSS REFERENCE

CAT REF. #	TYPE	MODEL YRS.	ENGINE	LITERS	MODEL SPECS.	KW	RPM	TURBO SVC #	REPLACED BY	TURBO P/N
0R7923	Truck	1994-01	3406E	14.64	S410G	404	1800	177148		704604-0007
0R-7924	Truck	1998-01	3406E, 3456, C16	15.8	S410G-105H55SAWM/1.65TM1	441	2100	175963		705152-0007
0R7978	Ford	2000-10	3126B	7	S300AG-83H36DSTM/0.80VTF74DA1	243	2400	178473		171813
0R7979	325C Excavator	2001-01	3126B	7	S200AG051	151	1800	178475		171860
0R7981	950 & 962 Loader	2000-11	3126B	7	S200AG-80H30BPABM/70UU9 0.70VTF	168	2200	178474		171859
0R7983					S200A049			179593		171857
0R9865	Truck	2000-10	3126	7	S200G046	170	2200	178089		171744
0R9956		2001-12			S3BSL164			178467		171376
0R9959	996X/810X Wheel loader	2000-09	3176	10.3	S3BSL	212	2100	178466		171368
0R9992	Marine	2000-01	3126E	7	S330W057	313	2800	179609		171475
100-5864					S2ESL			179568		166340
101-1684			3176,3176B		S3BSL102			179571		166490
101-7768		1992-07	3408	18	S4TS522	338		178132		199502
102-8410	960 Front Wheel Loader	1993-02	3116	6.6	S2EGL094	157	2300	179573		166773
103-0651		1993-03	3116 @215 HP	6.6	S2EGL099	160	2200	178070		166810
103-0652		1993-03	3116 @215 HP	6.6	S2EGL099	160	2200	178070		166811
103-0655			3116 @185,200 HP		S2EG099			178006		166802
103-2083		1993-02	3116 @250 HP	6.6	S2EG070	187	2200	178071		166813
103-2084		1993-02	3116 @250 HP	6.6	S2EG070	187	2200	178071		166812
103-2085		1993-02	3116	6.6	S2EGL069	138		178005		166799
103-2085			3116 @170,185 HP		S2EGL069			178005		166799
103-4051	Quarry truck		3412 775		S4DSL029			179572		166669
106-7407			3306		S3BSL119			179578		167384
107-2060	980F Loader	1993-12	3406 92 1/2 Model	14.6	S4DSL031			179596		167053
109-8186	Truck	1993-08	3176	10.3	S3AS019			178073		167181
109-8189	Truck	1993-08	3176	10.3	S3AS017			178074		167182
109-8191	Truck	1993-08	3176	10.3	S3AS017			178075		167183
109-8223	Truck	1993-08	3176	10.3	S2ESL051	261	1800	178010		167186
109-8224	Truck	1993-08	3176	10.3	S2ESL079	261		178076		167187
10R0183	Truck	2001-06	C10	10	S310S	246	1800	178477		172314
10R0208		2001-04	C10	10	S310G085	275	1800	178476		172313
10R0364	938G, 950G, 962G Wheel Loaders	2001-10	3126	7	S200G062	165	2200	178478		173106
10R0371	Tractor D6	2001-10	C9	9	S200AG048	156	2000	178472		171770
10R0470	775E OHT	2001-11	3412		S4DS538			179595		172537
10R0509		2009-01	3406	14.6	S4DSL031			179596		467053
10R0752	Loader 966G	2002-05	3306	10.3	S3BSL173	188	2200	178090		173139
10R0823	972 Loader	2002-04	C9	9	S310G080	232	2000	178479		173264
10R0921		2002-01	3306		S3BSL119			178480		173305
10R1011			3306 350H, C65D, 615		S3BSL128			179581		167972
10R1012					S3BSL128			179585		468443
10R1012		1995-06			S3BSL128			179585		168443
10R1416	Military vehicle	2002-09	3126	7	S300CG-83H33CKCUM/0.80VTF74DA1	261	2600	178481	177357	173687
10R1584	Wheel Loader 966G	2003-03	C10	10	S3BCL171	212	2100	178039		173760
10R1795	Truck	2003-04	3126/C7	7	S200AG-80H33DMTM/70UU9 0.70VTF	172	2200	178482		174200
10R1986	Marine	2003-10	C18L	18	S510W-110NJ1 120/67Z-G 1.44VOW		2100	174398		174398
10R2229	Truck/Bus	2004-02	C9	9	S310G117	212	2100	174556		174556
10R2230	RV	2003-12	C9	9	S310G116	294	2100	178483		174551
10R2231	Truck	2003-12	C9	9	S310G116	257	2100	178483		174554
10R2232	Bus	2003-12	C9	9	S310G116	246	2100	178483		174555
10R2315	Marine	2003-06	3196 / C12	12	S410W021			174175		174175
10R2355		2004-02	C9	9	S310C080	206	1800	178484		174755
10R2464	793 HD Truck	2004-10	3516 HD	70	S510C012	1776	1750	174858	176865	174858
10R2619	Scraper 637	2004-08	C9	9	S310G120	227	1999	174942		174942
10R2660		2004-08	C9	9	S310G122			178485	OE 179249	174978
10R3069	Truck	2005-02	C9	9	S310G116	210	2100	178483		175498
10R3280	Truck	2005-02	C7	7	S300G-83H36CU-TM0.80VTF74DA1	246		178046		175480
10R3281	Truck	2005-03	C7	7	S300AG-83H36CU-TM/0.80VTF74DA1	246		178047		175487



WWW.AREADIESEL.COM

AREA DIESEL SERVICE, INC.



CROSS REFERENCE

CAT REF. #	TYPE	MODEL YRS.	ENGINE	LITERS	MODEL SPECS.	KW	RPM	TURBO SVC #	REPLACED BY	TURBO P/N
10R6142	793 HD Truck	2007-07	3516B HD	70	S510C004	1715	1750	178469		176864
10R6143	793 HD Truck	2007-07	3516 HD	70	S510C012	1776	1750	176865		176865
10R6402	Various	2007-09	3126	7	S300CG-83H36DS-CUM/0.80BTF74DA1	261	2600	177357		177357
10R9751	Excavator	1992-04	3306 E345		S4DS022			179569		166353
110-6979	Truck	1993-07	3306	10.3	S3BGL114	224	2000	178009		167167
110-6980	Truck	1993-07	3306	10.3	S3BGL114	224	2000	178008		167166
110-6981	Truck	1993-07	3306	10.3	S3BGL114	224	2000	178009		167168
110-6982	Truck	1993-07	3306	10.3	S3BGL114	224	2000	178008		167164
110-7897	Marine		3406		S4DW033			178007		167157
111-1653	Industrial		3306 @325 HP		S3BSL115			179577		167185
113-1709					S3BSL102			179571		167366
113-7924					S3BSL120			179579		167386
114-4658		1994-01	3116 @250 HP	7	S2EGL100	187		178011		167197
114-4660		1994-01	3116 @250 HP	7	S2EGL100	187		178011		167199
116-9574			3406E	14.64	S410			174269		466423-0003
117-6514	Loader 998	1995-01	3408	18	S4DS034	326	2000	178079		167690
117-6514	Truck 769	1995-01	3408	18	S4DS034	326	2000	178079		167690
118-2025			3126 @190 HP		S200S001			179580		167433
118-2026		1994-06	3126 @250 HP	7	S200G001	187		178077		167434
118-2027	Truck	1994-06	3126 @275 HP	7	S200G001	205	2200	178078		167435
118-2284			3306 350H, C65D, 615		S3BSL128			179581		167972
119-9258		1994-09	3306 @300 HP	10.3	S3BGL114	234	2000	178013		167867
124-3030			3406E	14.64	S410			174269		466423-0004
124-3032			3406E @475 HP	14.64	S410G	355		177148		466445-0015
124-3034	Truck	1994-01	3406E	14.64	S410G	325	1800	174259		466445-0017
124-3035			3406E @425 HP	14.64	S410G	317		177148		466445-0018
124-3759	Truck	1994-01	3406E	14.64	S410G	372	1800	174260		471036-0001
124-9332		1995-03	3116	6.6	S2ESL094	130		178080		168190
125-1121	Motor Grader	1995-11	3116	6.6	S2ESL094	124	2000	178080		168358
125-1123	938F Loader	1995-11	3116T @110 HP	6.6	S2ESL105	82		178016		168360
125-1124	938F Loader	1995-10	3116T @180 HP	6.6	S2ESL105	134		179583		168362
125-1128	Excavator		3116T M318		S2ESL105			179584		168369
126-5420	Truck	1995-06	3126 @275/300 HP	7	S200G001	224	2200	178078		168416
127-5150		1995-06			S3BSL128			179585		168443
127-9331		1995-06	3126 @250 HP	7	S200G001	187		178077		168476
127-9332	Truck	1995-06	3126 @275/300 HP	7	S200G001	234	2200	178078		168477
130-5469	Truck Off-Highway	1995-10	3406C 773&775	14.6	S4DS-114H55DAXM/1.58VTF97H1	313	1900	178465		168665
130-7283		1995-08	3126	7	S200G001	187		178077		168698
131-2427	Truck	1999-01	3406C	14.59	S410G	315	1800	174259		471066-0001
132-3649	Truck	1994-01	3406E	14.64	S410G	372	1800	174260		471120-0001
132-3651	Truck	1994-01	3406E	14.64	S410G			174259		471119-0001
133-3221	Deuce		3126	7	S200G007	179	2400	178021		169244
133-9238	Truck	1996-01	3126 HEUI	7	S200G001	224	2200	178078		168909
134-3044		1996-03	3116	6.6	S2EGL094	130		178018		168932
134-3046		1996-03	3116	6.6	S2EGL094	130		178018		168936
135-2650			3116 @125/140 HP		S200S017			179586		169439
136-6390	Truck	1998-01	3406E @455 - 550 HP	14.64	S410G	404	1800	177148		471142-0003
136-7619	Truck	1996-07	3406E @355-410 HP	14.64	S410	305		174269		169060
137-4832		1996-07	3406C @425 HP	14.64	S410G	317		177148		169227
137-9834		1996-06	3126 @230/250 HP	7	S200G001	187		178077		169264
138-2104		1996-06	3126 @230/250 HP	7	S200G001	187		178077		169294
139-8466		1996-07	3126 @230/250 HP	7	S200G001	187		178077		169374
141-8936			3406E	14.64	S410			174269		466423-0005
141-8937			3406E @475 HP	14.64	S410G	355		177148		466445-0021
141-8938	Truck	1994-01	3406E	14.64	S410G	325	1800	174259		466445-0022
141-8939			3406E @425 HP	14.64	S410G	317		177148		466445-0023
141-9231	Truck	1996-09	3126 @275 HP	7	S200G001	205	2200	178078		169449
143-0522	Truck	1996-11	3306C	10.3	S3BGL114	224	1800	178023		169490
143-0523	Truck	1996-11	3306C	10.3	S3BGL114	224	1800	178024		169491
145-1697	Mining	1997-10	3306B	10.3	S3BSL159	123	2200	178025		169902



WWW.AREADIESEL.COM

AREA DIESEL SERVICE, INC.



CROSS REFERENCE

CAT REF. #	TYPE	MODEL YRS.	ENGINE	LITERS	MODEL SPECS.	KW	RPM	TURBO SVC #	REPLACED BY	P/N
145-6093		1997-03	3126	7	S200G001	187		178077		169592
145-6094	Truck	1997-03	3126 @275 HP	7	S200G001	205	2200	178078		169593
146-4328	Truck	1998-01	3406E @435 - 550 HP	14.64	S410G	404	1800	177148		471142-0005
151-3026	Euro Truck	1997-07	C10	10.3	S3BSL157			178026		169817
151-5262	Truck		3126 275/300 HP'98	7	S200G001	224	2200	178078		169820
152-7460	Marine		3126E		S330W057			179609	171475	170245
154-8677	Industrial	1997-12	3176C	10.3	S3BSL157	276	1800	178026		169941
155-5463		1997-11	3306 @300 HP	10.3	S3BGL082	234	2000	178066		169966
157-4386					S300W049			179588		170001
158-7875	Industrial	1997-12	3176C	10.3	S3BSL157	276	1800	178026		170023
159-8542	Truck	1998-01	3406E, 3456, C16	15.8	S410G-105H55SAWM/1.65TM1	441	2100	175963		471147-9007
160-5550		1998-04	3406E	14.64	S410	325		174269		170083
161-6352	Truck	1998-01	3406E, 3456, C16	15.8	S410G-105H55SAWM/1.65TM1	441	2100	175963		705152-0003
166-6752		1998-08	3406E Low HP	14.64	S410G			177148		170354
167-9271	Truck	1994-01	3406E	14.64	S410G	404	1800	177148		704604-0007
174-1644		2001-12			S3BSL164			178467		171376
176-7716	Truck	1999-01	3406E	14.59	S410G	320	1800	174259		704604-0006
177-0440	325C Excavator	2001-01	3126B	7	S200AG051	151	1800	178475		171860
185-5732	996X/810X Wheel loader	2000-09	3176	10.3	S3BSL	212	2100	178466		171368
185-8016	950 & 962 Loader	2000-11	3126B	7	S200AG-80H30BPABM/70UU9 0.70VTF	168	2200	178474		171859
186-2528	Truck	2000-09	3126B	7	S200S044	140	2200	178470		171726
186-2532	Truck	2000-10	3126	7	S200G046	170	2200	178089		171752
187-1603					S200A049			179593		171857
187-4446	Marine	2000-01	3126E	7	S330W057	313	2800	179609		171475
188-5156	Tractor D6	2000-11	C9	9	S200AG048	156	2000	178472		171770
190-4178					S200A048			179592		171840
191-8019	Truck	2000-04	3126B	7	S300G-83H36DS-PM/0.80VTF74DA1	246	2400	178029		171566
191-8020	Truck	2000-04	3126B	7	S300G-83H36DS-PM/0.80VTF74DA1	246	2400	178029		171563
191-8021	Truck	2000-04	3126B	7	S300G-83H36DS-PM/0.80VTF74DA1	246	2400	178029		171564
191-8022	Truck	2000-04	3126B	7	S300G-83H36DS-PM/0.80VTF74DA1	246	2400	178029		171565
191-8023	Truck	2000-04	3126B	7	S300G-83H36DS-PM/0.80VTF74DA1	246	2400	178029		171572
191-8024	Truck	2000-04	3126B	7	S300G-83H36DS-PM/0.80VTF74DA1	246	2400	178029		171570
191-8025	Truck	2000-04	3126B	7	S300G-83H36DS-PM/0.80VTF74DA1	246	2400	178029		171567
191-8026	Truck	2000-04	3126B	7	S300G-83H36DS-PM/0.80VTF74DA1	246	2400	178029		171568
191-8027	Truck	2000-04	3126B	7	S300G-83H36DS-PM/0.80VTF74DA1	246	2400	178029		171569
191-8028	Truck	2000-04	3126B	7	S300G-83H36DSPM/0.80VTF74DA1	224	2400	178468		171574
191-8029	Truck	2000-04	3126B	7	S300G-83H36DS-PM/0.80VTF74DA1	246	2400	178029		171596
192-0949	Truck	2000-04	3126B	7	S300G-83H36DSPM/0.80VTF74DA1	224	2400	178468		171595
193468		1984-05			4MF-731			178097		193468
193-5867	Truck	2000-05	3126B	7	S300G-83H36DSPM/0.80VTF74DA1	224	2400	178468		171636
194-2975	793 HD Truck	2000-08	3516B HD	70	S510C004	1715	1750	178469	176864	171654
194772					S4DS			178102		194772
194773			3306	10.3	S4DS011			178106		194773
194779			3406B	14.6	S4DS010			178104		194779
194781					S4DS010			178105		194781
194782					S4DS006			178103		194782
195-5992	Truck	2000-10	3126	7	S200G046	170	2200	178089		171747
195-5993	Truck	2000-10	3126	7	S200G046	170	2200	178089		171745
195-5994	Truck	2000-10	3126	7	S200G046	170	2200	178089		171746
195-5995	Truck	2000-10	3126	7	S200G046	170	2200	178089		171744
195-5996	Truck	2000-10	3126	7	S200G046	170	2200	178089		171748
195-5997	Truck	2000-10	3126	7	S200G046	170	2200	178089		171749
195-5998	Truck	2000-10	3126	7	S200G046	170	2200	178089		171750
195-5999	Truck	2000-10	3126	7	S200G046	170	2200	178089		171751
195-6000	Truck	2000-10	3126B	7	S200G-80H/33DM-TM/0.80VTF70UU9	172	2200	179590		171753
195-6013	Truck	2000-09	3126B	7	S200S044	140	2200	178470		171722
195-6015	Truck	2000-09	3126B	7	S200S044	140	2200	178470		171718
195-6016	Truck	2000-09	3126B	7	S200S044	140	2200	178470		171719
195-6018	Truck	2000-09	3126B	7	S200S044	140	2200	178470		171720
195-6019	Truck	2000-09	3126B	7	S200S044	140	2200	178470		171721



WWW.AREADIESEL.COM

AREA DIESEL SERVICE, INC.



CROSS REFERENCE

CAT REF. #	TYPE	MODEL YRS.	ENGINE	LITERS	MODEL SPECS.	KW	RPM	TURBO SVC #	REPLACED BY	TURBO P/N
195-6020	Truck	2000-09	3126B	7	S200S044	140	2200	178470		171717
195-6021	Truck	2000-09	3126B	7	S200S044	140	2200	178470		171723
195-6022	Truck	2000-09	3126B	7	S200S044	140	2200	178470		171724
195-6023	Truck	2000-09	3126B	7	S200S044	140	2200	178470		171725
195-6024	Truck	2000-09	3126B	7	S200A045	140	2200	178031		171730
195-6029	938G, 950G, 962G Wheel Loaders	2000-10	3126	7	S200G052	116	2200	179594		171963
196-4406	Marine	2006-02	C9	9	S410WG047	392		179591		171765
196-5951	Truck	1994-01	3406E	14.64	S410G	404	1800	177148		704604-0007
196-5952	Truck	1998-01	3406E, 3456, C16	15.8	S410G-105H55SAWM/1.65TM1	441	2100	175963		705152-0007
197-4998	Ford	2000-10	3126B	7	S300AG-83H36DSTM/0.80VTF74DA1	243	2400	178473		171813
198-1845	938G, 950G, 962G Wheel Loaders	2001-10	3126	7	S200G062	165	2200	178478		173106
198-1846	938G, 950G, 962G Wheel Loaders	2001-10	3126	7	S200G062	165	2200	178478		173107
198-8717	Truck	2000-12	3126B	7	S300G-83H36DSPM/0.80VTF74DA1	224	2400	178468		171998
198-8718	Truck	2000-12	3126B	7	S300G-83H36DSPM/0.80VTF74DA1	224	2400	178468		171999
198-8720	Truck	2000-12	3126B	7	S300G-83H36DSPM/0.80VTF74DA1	224	2400	178468		172000
198-8721	Truck	2000-12	3126B	7	S300G-83H36DSPM/0.80VTF74DA1	224	2400	178468		172001
198-8722	Truck	2000-12	3126B	7	S300G-83H36DSPM/0.80VTF74DA1	224	2400	178468		172002
198-8723	Truck	2000-12	3126B	7	S300G-83H36DSPM/0.80VTF74DA1	224	2400	178468		172003
198-8724	Truck	2000-12	3126B	7	S300G-83H36DSPM/0.80VTF74DA1	224	2400	178468		172004
198-8725	Truck	2000-12	3126B	7	S300G-83H36DSPM/0.80VTF74DA1	224	2400	178468		172005
198-8726	Truck	2000-12	3126B	7	S300G-83H36DSPM/0.80VTF74DA1	224	2400	178468		172006
198-8727	Truck	2000-12	3126B	7	S300G-83H36DSPM/0.80VTF74DA1	224	2400	178468		172007
1P0034	955 Loader		3304		3LK-275			155431	172494	155431
1P1251		1970-12			4HF-854			155440		155440
1P6082		1970-02			4MD-455			178001		151905
1P6082			G633C		4MD-455			178001		151905
1P6083		1970-02	G379A		4MD-455			178133		151906
1P6084		1970-02	D353D		4MD-455			178134		151907
1P6085					4MD-755			178095		146577
1S7875		1970-02	D353D		4MD-455			178134		151907
1W1809		1982-02	3408	18	4MF-731			178097		186553
1W3728			3306		4MF-721			179601		187166
1W3897			3408		4MF-731			179602		187178
1W9157					EC-283			179603		188149
1W9757			3306		EC-283			179603		188149
204-6489	Truck	2001-06	C10	10	S310S	246	1800	178477		172314
204-6490	Truck	2001-06	C10	10	S310S	246	1800	178477		172347
204-6491		2001-04	C10	10	S310G085	275	1800	178476		172313
204-6492	Truck	2001-05	C10	10	S310G085	275	1800	178476		172345
206-2635	Loader 966G	2002-05	3306	10.3	S3BSL173	188	2200	178090		173139
207-7458	775E OHT	2001-11	3412		S4DS538			179595		172537
211-1023		2009-01	3406	14.6	S4DSL031			179596		167053
216-7815	972 Loader	2002-04	C9	9	S310G080	232	2000	178479		173264
217-3007	Truck	2002-01	3126B	7	S200A045	140	2200	178031		173268
217-3009	Truck	2002-01	3126B @250-330 HP	7	S300AG-83H36DSTM/0.80VTF74DA1	243	2400	178473		173270
219-1911		2002-01	3306		S3BSL119			178480		173305
219-9710			3306 350H, C65D, 615		S3BSL128			179581		167972
219-9711		1995-06			S3BSL128			179585		168443
224-7102		2002-07	C10	10	S310G085			173555		173555
224-8664	Truck	2003-02	3126B	7	S300G-83H36DS-PM/0.80VTF74DA1	243	2400	178029		173556
226-9411	Truck	2002-08	3126B	7	S200A045	140	2200	178031		173616
226-9413	Truck	2002-08	3126B	7	S300AG-83H36DSTM/0.80VTF74DA1	243	2400	178473		173618
228-3213	Truck	2003-01	C7	7	S200G-80H/33DM-TM/0.80VTF70UU9	172	2200	173689		173689
228-3214	Truck	2003-01	C7	7	S200G-80H/33DM-TM/0.80VTF70UU9	172	2200	173690		173690
228-3215	Truck	2003-01	C7	7	S200G-80H/33DM-TM/0.80VTF70UU9	172	2200	173691		173691
228-3216	Truck	2003-02	C7	7	S200G-80H/33DM-TM/0.80VTF70UU9	172	2200	173692		173692
228-3217	Truck	2003-01	C7	7	S200G-80H/33DM-TM/0.80VTF70UU9	172	2200	173693		173693
228-3218	Truck	2003-03	C7	7	S200G-80H/33DM-TM/0.80VTF70UU9	172	2200	173694		173694



WWW.AREADIESEL.COM

AREA DIESEL SERVICE, INC.



CROSS REFERENCE

CAT REF. #	TYPE	MODEL YRS.	ENGINE	LITERS	MODEL SPECS.	KW	RPM	TURBO SVC #	REPLACED BY	TURBO P/N
228-4737	Military vehicle	2002-09	3126	7	S300CG-83H33CKCUM/0.80VTF74DA1	261	2600	178481	177357	173687
230-5107	Wheel Loader 966G	2003-03	C10	10	S3BCL171	212	2100	178039		173760
237-5250	Truck	2003-04	C7	7	S200AG-80H33DMTM/70UU9 0.70VTF	172	2200	178482		174194
237-5251	Truck	2003-04	C7	7	S200AG-80H33DMTM/70UU9 0.70VTF	172	2200	178482		174197
237-5252	Truck	2003-04	C7	7	S200AG-80H33DMTM/70UU9 0.70VTF	172	2200	178482		174195
237-5253	Truck	2003-04	C7	7	S200AG-80H33DMTM/70UU9 0.70VTF	172	2200	178482		174196
237-5254	Truck	2003-04	C7	7	S200AG-80H33DMTM/70UU9 0.70VTF	172	2200	178482		174193
237-5255	Truck	2003-04	C7	7	S200AG-80H33DMTM/70UU9 0.70VTF	172	2200	178482		174198
237-5270	Truck	2003-04	3126	7	S200AG-80H33DMTM/70UU9 0.70VTF	172	2200	178482		174201
237-5271	Truck	2003-04	3126/C7	7	S200AG-80H33DMTM/70UU9 0.70VTF	172	2200	178482		174200
237-5272	Truck	2003-04	3126	7	S200AG-80H33DMTM/70UU9 0.70VTF	172	2200	178482		174202
238-5057	Truck	2003-04	C7	7	S200AG-80H33DMTM/70UU9 0.70VTF	172	2200	178482		174235
242-0267	Marine	2003-10	C18L	18	S510W-110NJ1 120/67Z-G 1.44VOW		2100	174398		174398
243-2561	Marine	2003-06	3196 / C12	12	S410W021			174175		174175
243-2704	Bus	2003-12	C9	9	S310G116	246	2100	178483		174555
243-5480	Truck	2003-12	C9	9	S310G116	257	2100	178483		174554
246-8142	RV	2003-12	C9	9	S310G116	294	2100	178483		174551
246-9123	Truck/Bus	2004-02	C9	9	S310G117	212	2100	174556		174556
248-5246		2004-02	C9	9	S310C080	206	1800	178484		174755
250-0841	Loader 950H, 962H, IT62	2005-06	C7	7	B2-80N/30CA-ABM/0.70VTF70UU9	168	1800	179598		175828
250-0843	Scraper 637	2004-08	C9	9	S310G120	227	1999	174942		174942
250-7701		2004-08	C9	9	S310G122			178485	179249	174978
252-1603	793 HD Truck	2004-10	3516 HD	70	S510C012	1776	1750	174858	176865	174858
254-2081	Gen Set 50 Hz	2005-04	H18 EPG	18	S310S089 87H/39DH-ANM 1.00VO 80BM1	640	1500	178044		175150
254-2082	Gen Set 50 Hz	2005-04	H18 EPG	18	S310S089 87H/39DH-ANM 1.00VO 80BM1	640	1500	178044		175151
254-8938	789 HAA Truck	2004-08	3516 HD	70	S510C004	1417	1750	174954	176866	174954
263-9615	Truck	2005-02	C9	9	S310G116	210	2100	178483		175498
269-2915	Truck	2005-02	C7	7	S300G-83H36CU-TM0.80VTF74DA1	246		178046		175475
269-2916	Truck	2005-02	C7	7	S300G-83H36CU-TM0.80VTF74DA1	246		178046		175476
269-2917	Truck	2005-02	C7	7	S300G-83H36CU-TM0.80VTF74DA1	246		178046		175477
269-2918	Truck	2005-02	C7	7	S300G-83H36CU-TM0.80VTF74DA1	246		178046		175478
269-2919	Truck	2005-02	C7	7	S300G-83H36CU-TM0.80VTF74DA1	246		178046		175479
269-2920	Truck	2005-02	C7	7	S300G-83H36CU-TM0.80VTF74DA1	246		178046		175480
269-2921	Truck	2005-02	C7	7	S300G-83H36CU-TM0.80VTF74DA1	246		178046		175481
269-2922	Truck	2005-02	C7	7	S300G-83H36CU-TM0.80VTF74DA1	246		178046		175482
269-2923	Truck	2005-02	C7	7	S300G-83H36CU-TM0.80VTF74DA1	246		178046		175483
269-2924	Truck	2005-02	C7	7	S300G-83H36CU-TM0.80VTF74DA1	246		178046		175484
269-2925	Truck	2005-02	C7	7	S300G-83H36CU-TM0.80VTF74DA1	246		178046		175485
269-2926	Truck	2005-02	C7	7	S300G-83H36CU-TM0.80VTF74DA1	246		178046		175486
269-2927	Truck	2005-03	C7	7	S300AG-83H36CU-TM/0.80VTF74DA1	246		178047		175487
290-4044	Stryker	2008-02	C7	7	S300CG-83H36DSPM/0.80VTF74DA1	258	2600	176488		176488
2S2497			D330A		4MD-354			144499	144199	144499
301-4202	793 HD Truck	2007-07	3516B HD	70	S510C004	1715	1750	178469		176864
301-4203	793 HD Truck	2007-07	3516 HD	70	S510C012	1776	1750	176865		176865
301-4204	789 HAA Truck	2007-07	3516 HD	70	S510C004	1417	1750	176866		176866
30-35004					4MFW-731			193465		193465
304-9449	Marine	2007-07	3512B HD	51.8	S510C005	1119	1200	176872		176872
307-8324	Various	2007-09	3126	7	S300CG-83H36DS-CUM/0.80BTF74DA1	261	2600	177357		177357
345-6947	Shovel	2009-10	C18	18	S310C148-83N/36DJ-ABM 1.10VOF80BM1			178898		178898
345-6948	Shovel	2009-10	C18	18	S310C148-83N/36DJ-ABM 1.10VOF80BM1			178899		178899
346-0557	Military vehicle	2009-07	C7	7	S300CG-83H36DSPM/0.80VTF74DA1	283	2600	178963		178963
3S3512					4MD-351			143142		143142
3S4251					4MD-455			177999		146252
3S4258		1974-12	3306		4MD-354			177998		143145
3S4259					4MD-354			144199		144199
3S4414					4MD-354			144204		144204
3S4420					4MD-354			144499	144199	144499
3S4420			D330		4MD-354			144499	144199	144499
3S4422					4MD-455			178001		151905
3S4428					4MD-355			143514		143514
3S4428			D379A		4MD-355			143514		143514



WWW.AREADIESEL.COM

AREA DIESEL SERVICE, INC.



CROSS REFERENCE

CAT REF. #	TYPE	MODEL YRS.	ENGINE	LITERS	MODEL SPECS.	KW	RPM	TURBO SVC #	REPLACED BY	TURBO P/N
3S4431					4MD-455			177999		146252
3S4431			D353D		4MD-455			177999		146252
3S4439			D353D		4MD-454			146992		146992
3S9241					E-304			149954		149954
4A2651					4MD-454			147340		147340
4N4565			D399		4HD-857			157876		157876
4N8882		1974-05	3408	18	4MF-731			178093		181009
4N9541			3306		4LF-504			180318		180318
4N9543			D346		E-414			180298		180298
4N9550		1973-12			F-654			180305		180305
4N9550			D379B		F-654			180305		180305
4N9551		1973-12			F-654			180307		180307
4N9551			D379B		F-654			180307		180307
4N9554		1981-06	3306		E-504			178048		180288
4N9555		1973-12	3306		4LE-504			178049		180289
4N9618		1981-06	3306		E-504			178048		180287
4P2059	Truck	1990-09	3406	14.6	S3BSL059			178130		199079
4P2060	Truck	1990-03	3406B	14.6	S3BSL058	261	1900	178062		199086
4P2061		1990-02	3406	14.6	S4DS025	261	2100	178131		199114
4P2061	Truck	1990-02	3406B	14.6	S4DS025	261	2100	178131		199114
4P2458	Truck	1990-02	3406B	14.6	S4DS025	343	1800	178063		199119
4P4682	Industrial	1990-06	3116T	7	S2BS001			178064		199292
4P4683	Industrial	1990-06	3116TA, HS	7	S2BS001			178064		199293
4P4684	Industrial	1990-06	3116T	7	S2BS001			178064		199294
4P4685	Industrial	1990-06	3116TA	7	S2BS001			178064		199295
4P5189		1990-08	3406B		S4DS027	257	2200	178065		199351
4P7499		1991-05	3406	14.6	S4DC028			179608		199515
4P9584	Truck	1991-04	3306	10.3	S3BGL082	224	2000	178066		199661
4P9585		1991-04	3306	10.3	S3BGL114	224	2000	178013	167867	199662
4P9585	Truck	1991-04	3306	10.3	S3BGL114	224	2000	178013	167867	199662
4R9147		1992-03	3116 @225 HP	6.6	S2EG070	168	2200	178071		166214
6I3739	Excavator	1992-04	3306 E345		S4DS022			179569		166353
6I4574			3406E	14.64	S410			174269		466423-0001
6N1571		1972-07	3306		3LM-319			172493		180189
6N1661		1974-05	3408	18	4MF-731			178093		181010
6N2020	Marine, Marine Gen Set	1974-02	3412		4MFW-781			193472		180359
6N5542		1975-01	D379B		4HF-455			181383		181383
6N7519		1981-09	3306	10.3	4LF-302			173721		182453
6N7812			3412		4MF-781			179599		182469
6N7924					3LM-289			172494		182248
6N8218			D379B		F-302			172488		182765
6N8458			D353D		4HD-755			178050		182779
6N8458		1976-06	D353D		4HD-755			178050		182779
6N8459		1976-06	D399		4HD-857			178051		182780
6N8460			D399		4HD-857			178051		316213
6N8460		1976-06	D399		4HD-857			178051		182781
6N8461		1976-06			4HF-864			182782		182782
6N8461			D399		4HF-864			182782		182782
6N8462		1976-06	D399		4HF-857			178052		182783
6N8636		1976-06	D399		4MD-755			178095		182831
6N9509		1976-06	D349		4HF-844			182825		182825
7C2485					F-555			179576		194848
7C3856	Ski track roller	1986-01	3208 DITA		4TF-606	209	2600	194989		194989
7C7578		1987-02	3306	10.3	S4DS001			178101		196542
7C7579					S4DS			178102		313658
7C7579		1987-02			S4DS			178102		196543
7C7580			3306	10.3	S4DS011			178106		311161
7C7580		1987-02	3306	10.3	S4DS011			178106		196554
7C7582	Industrial	1987-02	3306		S4DS			179605		196552
7C7587			3306B	10.3	S4DS			178107		312637
7C7587		1986-12	3306B	10.3	S4DS			178107		196557



WWW.AREADIESEL.COM

AREA DIESEL SERVICE, INC.



CROSS REFERENCE

CAT REF. #	TYPE	MODEL YRS.	ENGINE	LITERS	MODEL SPECS.	KW	RPM	TURBO SVC #	REPLACED BY	TURBO P/N
7C7685			3406B		S4DS010			178104		313014
7C7685		1987-01	3406B	14.6	S4DS010			178104		196548
7C7687			3406	14.6	S4DS010			178105		312006
7C7687		1987-01	3406	14.6	S4DS010			178105		196549
7C7689		1987-01	3406B	14.6	S4DS006			178103		196544
7C7691			3406 D8N		S4DS006			178059		313013
7C7691		1991-05	3406 D8N		S4DS006			178059		196547
7C7692			3406		S4DC006			178108		313008
7C7692		1987-05	3406	14.6	S4DC006			178108		196564
7E0460		1989-07	3406 @ 460		S4TS508	343		178120		198123
7E5187	Industrial		3114		S2AS015			199106		199106
7N2515			D398B, 3306		F-302			172487		183200
7N5892			D333C		E-302			172491		183846
7N7555		1974-05	3408	18	4MF-731			178093		184111
7N7748			3306		3LM-373			172495		184119
7N7753		1977-05	D349		4HD-864			184140		184140
7S1779					4MD-755			178095		146577
7S8757					4MD-454			147340		147340
7S8757			D333A		4MD-454			147340		147340
7W9568	Truck	1990-02	3406B	14.6	S4DS025	343	1800	178063		466372-X002
8M4084					4MD-455			177999		146252
8M6823					4B-354			138332		138332
8M6823			D318G		4B-354			138332		138332
8M6825					4B-354			137786		137786
8M6825			D318G		4B-354			137786		137786
8N3322					4HF-857			178052		184979
8N3323	Industrial	1979-03			4HF-857			178052		184980
8N5918		1979-08			V4HD-855			178096		185490
8N5919					V4HD-855			178096		185491
8N7320			3306		FC-302			172497		185638
8N9247			3306		3LM-373			172496		185841
8S2743					4ME-455			147738		147738
8S2743			D379B		4ME-455			147738		147738
8S9235		1981-06			E-504			149292		149292
8S9235			D334		E-504			149292		149292
8S9239		1981-10			E-304			149170		149170
8S9241		1981-10			E-304			149954		149954
8S9242		1981-10			E-304			178000		149955
8S9245		1981-06			E-204			149958		149958
9M7524					4B-351			139336		139336
9M7524					4B-351			139336		139336
9N0888		1974-05	3408	18	4MF-731			178093		180218
9N0893		1974-05	3408	18	4MF-731			178093		180219
9N1287			3306		E-302			172491		180660
9N6054		1979-06			4TF-555			178053		185564
9Y7756	Marine		3208 @375 HP		S4DW018			179606		197762
9Y9198	Gen Set		3406 @50 Hz		S4TS507			179607		198053
					F-302			172489		172489
	Air Compressor	1996-06	3304G		S2BW085	100	2100	169310		169310
	Various	2000-09	3306	10.3	E-302			171992		171992
	Various	2000-09	3306	10.3	F-302			171993		171993
	Various	2000-09	3306	10.3	F-302			171994		171994
	Various	2000-09	3306	10.3	F-302			171995		171995
	Various	2000-09	3306	10.3	F-302			171996		171996

ANY AND ALL MANUFACTURER NAMES, MODELS, PART NUMBERS, AND PRODUCT IMAGES HEREIN ARE PROPERTY OF THEIR RESPECTIVE OWNERS AND ARE BEING USED FOR REFERENCE PURPOSES ONLY. PRICING AND AVAILABILITY ARE SUBJECT TO CHANGE.







WWW.AREADIESEL.COM

AREA DIESEL SERVICE, INC.



(800) 637-2658 - 1300 N UNIVERSITY ST. CARLINVILLE, ILLINOIS 62626
 (800) 237-4692 - 1440 NE 56TH ST. PLEASANT HILL, IOWA 50327
 (317) 203-3331 - 5732 W 71ST ST. INDIANAPOLIS, INDIANA 46278

Application	Delphi Reman Part No.	OE/Reman Part No.	Features/Benefits
 <p>CAT® Remanufactured C13 Injectors</p>	EX63297	10R2977, 249-0708	<ul style="list-style-type: none"> • New, unique trim code. • New actuator assembly - spill valve NOP spring, washer, shim & stop in each injector. • 100% O-ring replacement. • 12 month, unlimited mileage warranty. • 90 day, no-hassle warranty.
 <p>CAT® Remanufactured C10/C12 Injectors</p>	EX630961 EX630963 EX630967 EX630968	10R0961 10R0963 10R0967 10R0968	<ul style="list-style-type: none"> • New Actuator Assembly. • New Spill Valve and HP Washer. • 100% O-ring replacement. • Nozzle 100% flow tested. • 12 month, unlimited mileage warranty. • 90 day, no-hassle warranty.
 <p>CAT® Remanufactured 3406E & C15 Injectors</p>	EX630955	10R0955, 211-3025	<ul style="list-style-type: none"> • Surface lapping of each critical component. • New actuator assembly - spill valve solenoid*, NOP spring, washer, shim & stop in each injector. • 100% O-ring replacement. • 100% New Nozzle Replacement on C15 Injectors. • Nozzle 100% flow tested on 3406E Injectors. • 12 month, unlimited mileage warranty. • 90 day, no-hassle warranty. <p>*C15 solenoids are replaced as needed</p>  <p>Not Just Quality. Delphi Quality.</p>
	EX630956	10R0956, 10R2782, 0R4332, 0R4895, 0R9256, 102-6236, 109-5038, 117-0481, 118-7929, 188-9027, 140-8951, 159-2631, 191-3002, 211-3022,	
	EX630957	10R0957, 10R2781, 10R8501, 0R4119, 0R4300, 0R4331, 0R4894, 0R9257, 103-4562, 109-5021, 117-0482, 118-8010, 118-9030, 140-8993, 159-2479, 191-3003, 211-3023	
	EX630958	10R0958, 10R2780, 0R4118, 0R4668, 0R4893, 0R9258, 102-6230, 117-1146, 117-1148, 118-9035, 152-3680, 191-3004, 211-3024, 211-3027	
	EX631273	10R1273, 239-4909, 249-0709	
	EX635919	10R1000, 229-5919	

ANY AND ALL MANUFACTURER NAMES, MODELS, PART NUMBERS, AND PRODUCT IMAGES HEREIN ARE PROPERTY OF THEIR RESPECTIVE OWNERS AND ARE BEING USED FOR REFERENCE PURPOSES ONLY. PRICING AND AVAILABILITY ARE SUBJECT TO CHANGE.



WWW.AREADIESEL.COM